

## V1030 64 HANDRAIL BRACKET

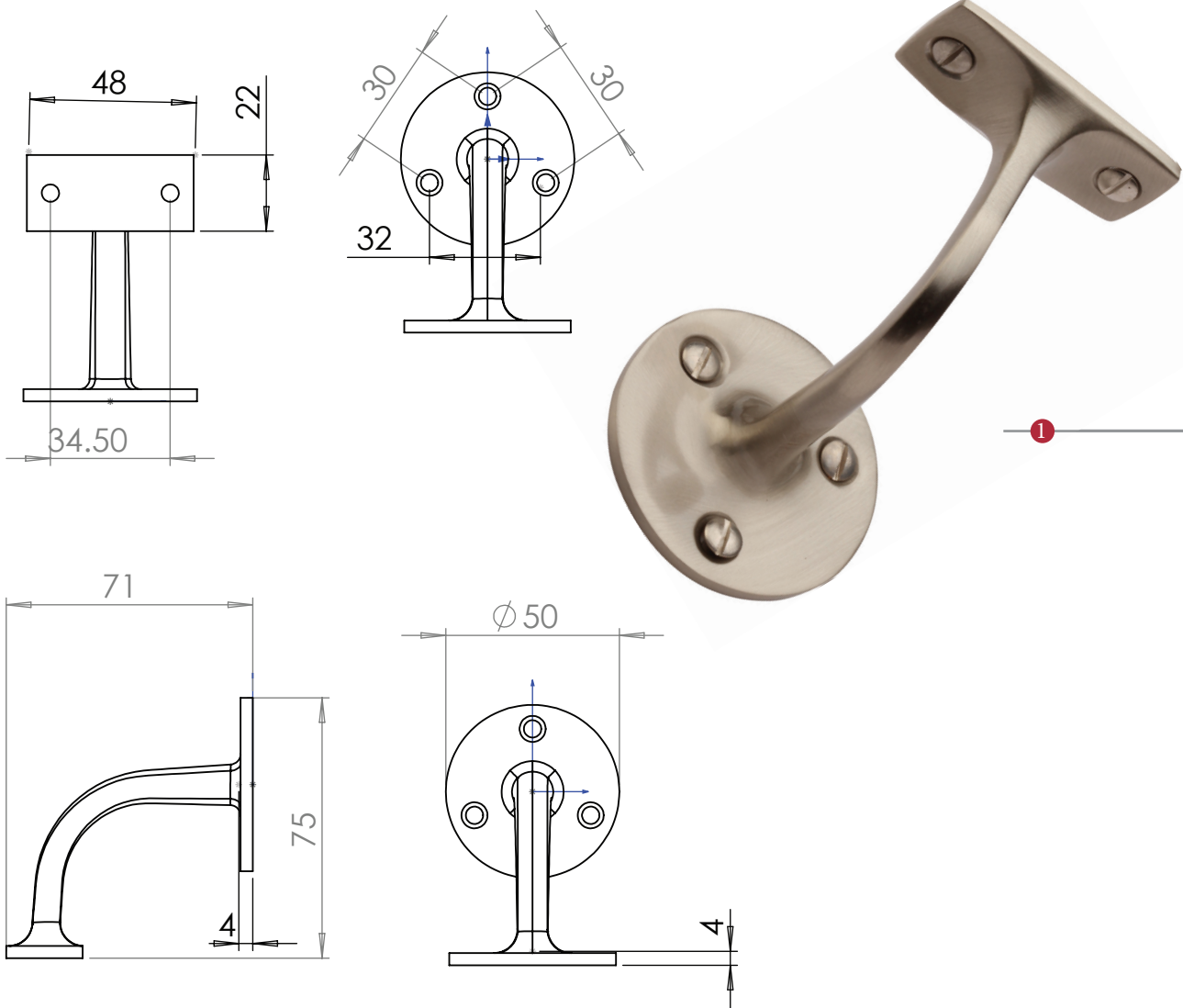

V1030 64  
Projection: 2½" (64mm)

② Dimensions of Handrail Bracket  
V1030 64  
see the outlines given above

③



30mm screws











36mm screws



Starter screw

### FINISHES

-  Polished Brass finish
-  Polished Chrome finish
-  Antique Brass finish
-  Satin Chrome finish
-  Satin Nickel finish
-  Matt Bronze finish
-  Satin Brass finish
-  Polished Nickel finish

### Overview

①

Handrail Bracket  
(illustrated)

②

(General Dimensions  
of Handrail Bracket)

③

Supplied with: (1 x Starter screw)  
3 x 36mm screws  
2 x 30mm screws

  
**M Marcus Ltd., Dudley**

Product Code

V1030 64

Material

Solid Brass

Available in all Heritage Brass finishes.

Sizes shown are in mm and approximate.  
We reserve the right to amend where  
necessary and without any prior notice.