

THE COLONIAL LEVER LATCH

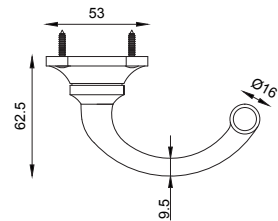

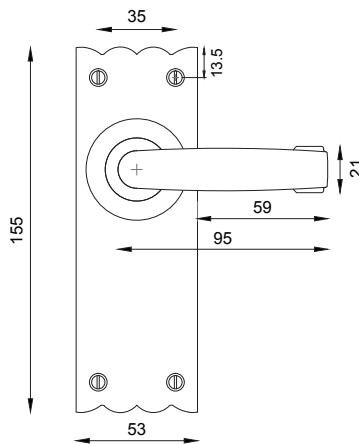

1
INSIDE / OUTSIDE VIEW

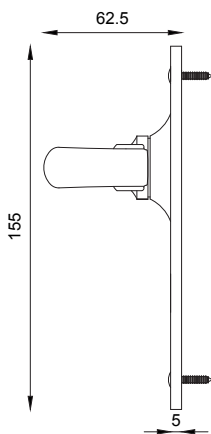

This latch handle is suitable for use with most U.K. tubular latches.

For a new door installation we would recommend for use with our York standard tubular latch with black finished strikes ref: YKTL23 (2.5") or YKTL33 (3")

- 2 
Spindle : 7.8mm x 80mm - 1pc.

Spindle : 7.8mm x 90mm - 1pc.

- 3 
No. 6 x 25mm Steel starter screw x 1pc.
Drill pilot holes, use the starter screw to cut a thread

- 4 
No. 6 x 19mm Black-Nickel Plated
Stainless Steel (SS) wood screw x 8pcs.
Fasten the SS screw into the pilot hole

Box Contains	1	2	3	4
	1 x Lever Handle Pair	1x 80mm spindle for 35mm door 1x 90mm spindle for 45mm door	1x Steel pilot wood screw	8x SS wood screws

M Marcus Ltd., Dudley

Material	Date	Product Code	Description	Sizes shown are in mm and approximate. We reserve the right to amend where necessary and without any prior notice.
Malleable Iron	23 July 2016	TC315	The Colonial Lever Latch	