

ADAM EURO PROFILE LOCK HANDLE

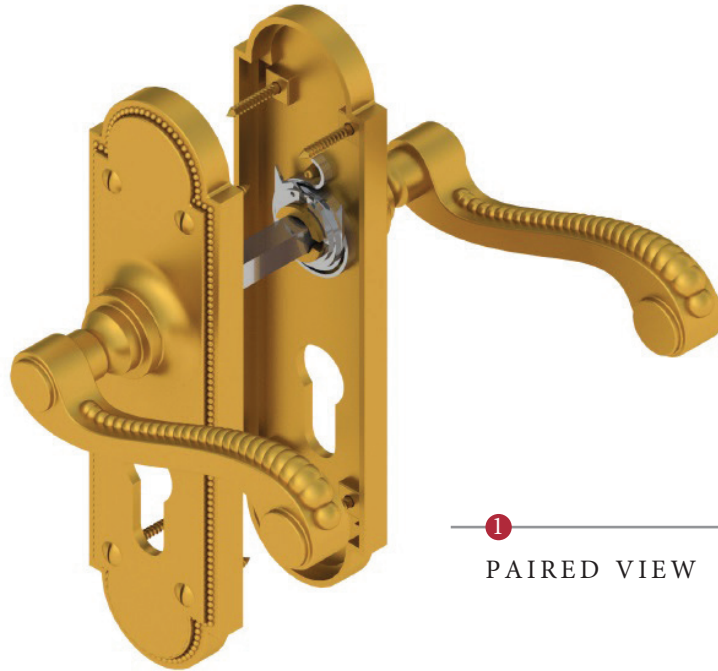

1  
PAIRED VIEW

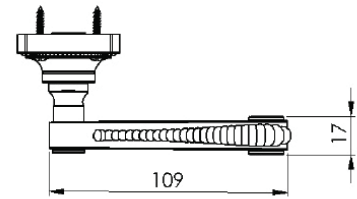
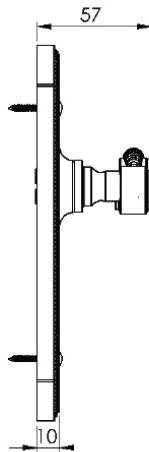
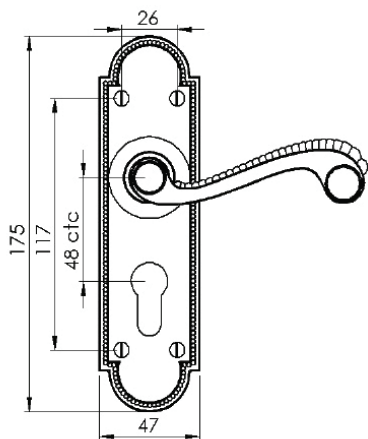

This lock handle is suitable for use with most U.K. Euro Profile cylinders and sashlocks with a 48mm CTC.

EURO PROFILE SASHLOCKS

with a 48mm CTC  
(not Included, must be ordered separately)

- YKCSLE27.CE 2.1/2" PVD Brass Finish
- YKCSLE28.CE 2.1/2" PSS
- YKCSLE29.CE 2.1/2" SSS
- YKCSLE37.CE 3" PVD Brass Finish
- YKCSLE38.CE 3" PSS
- YKCSLE39.CE 3" SSS

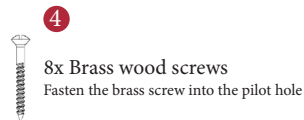
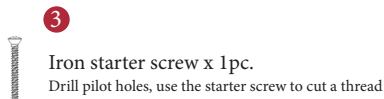
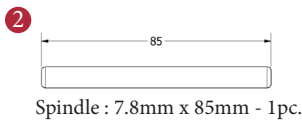

Box  
Contains

1	2	3	4
Pair of lever handles	1x 85mm spindle suitable for 35mm & 45mm thick door	1x Iron screw	8x Brass wood screws

  
M Marcus Ltd., Dudley

Product Code

R768

Material

Solid Brass

Available in all Heritage Brass finishes.

Sizes shown are in mm and approximate. We reserve the right to amend where necessary and without any prior notice.