

BR2140 8 ARCH SHELF BRACKET

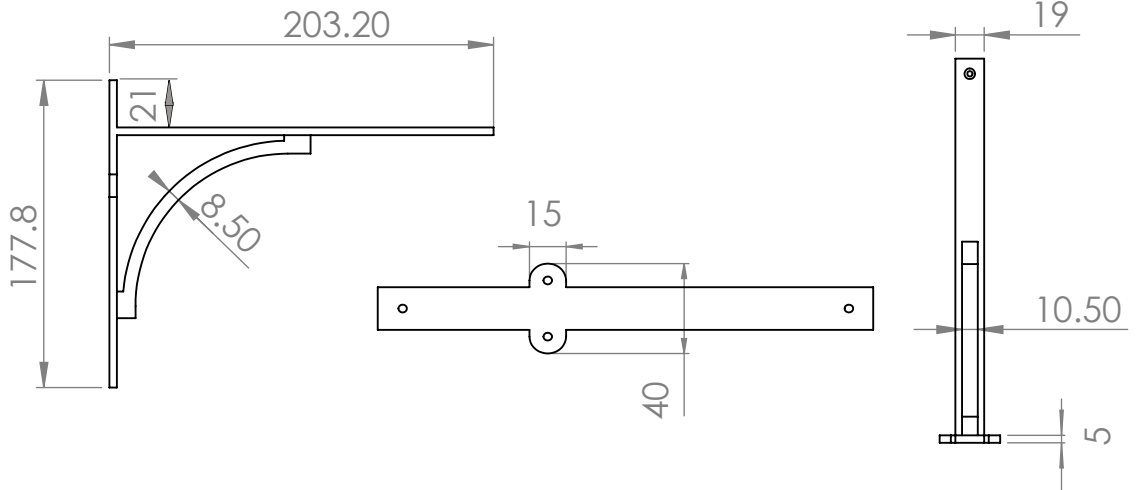

② Dimensions: see the outlines given above

③ 4 x rawl plugs

Starter screw x 1pc.
Drill pilot holes, use the starter screw to cut a thread

1 x 25mm screw
screw for shelf to bracket fixing

1 x 30mm screw
screw for shelf to bracket fixing

4 x 35mm mounting screws
screws for wall mounting

FINISHES

- ME Matt Bronze finish
- SB Satin Brass finish
- SN Satin Nickel finish
- AT Antique Brass finish
- SC Satin Chrome finish
- BK Matt Black finish

Overview

① Arch Shelf Brackett illustrated

② General Dimensions of Arch Shelf Bracket

③ Supplied: Starter screw & rawl plugs
4 x wall mounting screws
2 x shelf to bracket fixing options

M Marcus Ltd., Dudley

Product Code

BR2140 8

Material

Solid Brass

Sizes shown are in mm and approximate. We reserve the right to amend where necessary and without any prior notice.